

Draw scale diagrams (1cm = 1N) to work out the Resultant force in each of these cases:

Example:

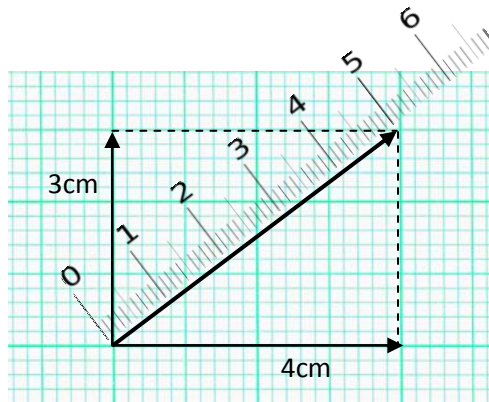
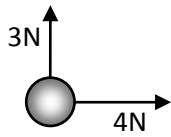

Answer: The Resultant force = 5N

1.

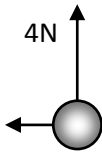

2.

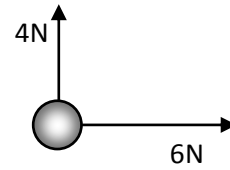

3.

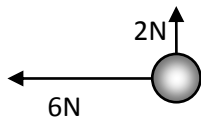

4.

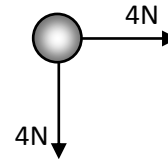

5.

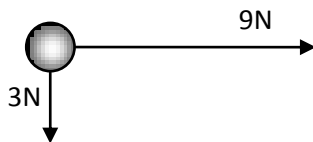

6.

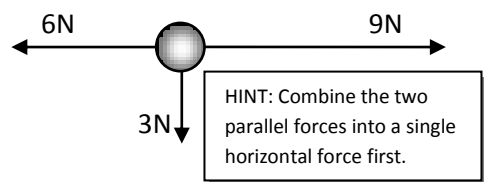

7.

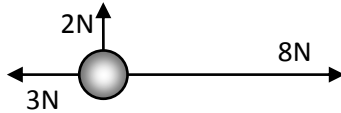

8.

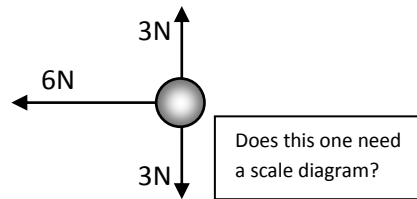

9.

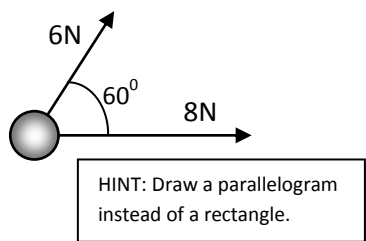

10.

